

JVC



LYT1944-001A

CU-VD50AA / AG

DVD Burner *INSTRUCTIONS*

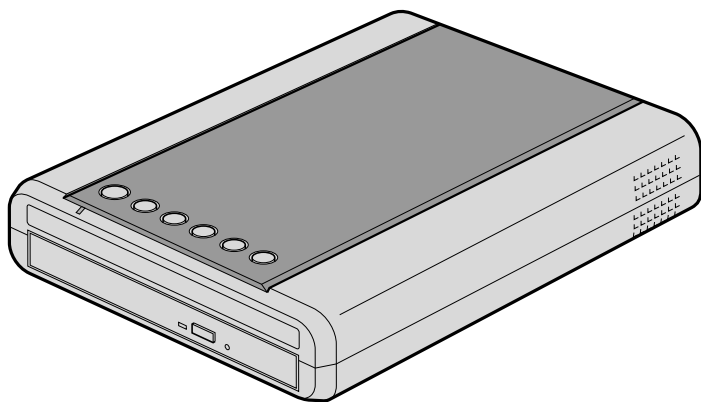

Getting Ready to Copy to a DVD!

1 Get ready a recommended disc

Use DVD-R, DVD-RW or DVD-R DL disc of the brands listed below. DVD+R, DVD+RW and DVD-RAM discs cannot be used.

	DVD-R	DVD-RW	DVD-R DL (Single-sided double layer)
Brand	JVC, TDK, Verbatim, SONY	JVC	JVC, Verbatim

Caution

- DVD-R DL (single-sided double layer) discs can be used only when the burner is connected to a high definition Everio camera.
- Use a commercially available cleaning cloth to wipe the disc gently if there are any fingerprints or dirt. Applying too much strength will result in scratches.
- Do not use discs that are scratched.

2 Connect

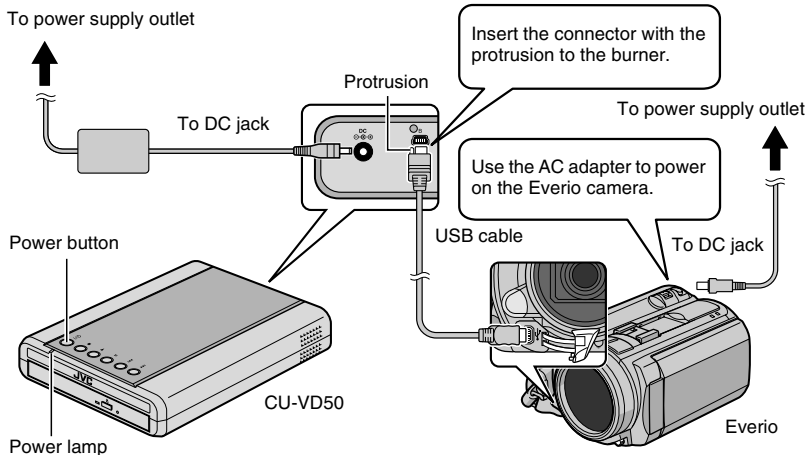

3 Press the power button to turn on the burner

- The power lamp changes from **blinking orange** to **steady orange**.

• When an AVCHD disc (P. 15) is inserted into a device that is not AVCHD-compatible, you may not be able to eject the disc. To eject the disc, refer to the instruction manual of your device.

4 Open the tray and insert the disc

Caution

- The tray cannot be opened/closed when the burner is off.

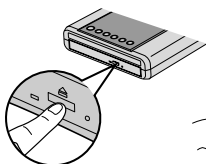

① Press the eject button.

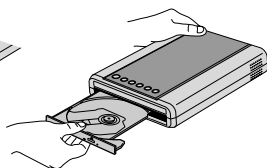

② Pull out completely.

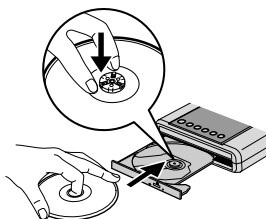

③ Insert firmly into place.

5 Close the tray

- Push in until the tray **snaps in**.

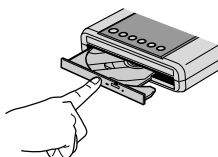

6 Open the LCD monitor

- The Everio camera turns on.
- The power lamp on the burner changes from **orange** to **green** light.

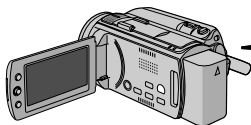

An hourglass (⌚) is displayed when the burner is recognising the disc. When completed, the following screen appears.

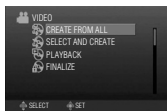

Pay attention to the following!

- Do not touch the recording side

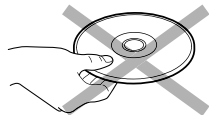

- Do not place any objects on top

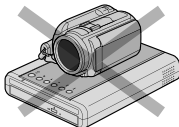

- Do not topple
- Do not subject to mechanical shock

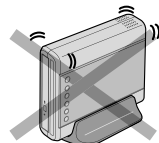

★ Recording or playback may not function properly if the disc is scratched or dirty.

Copying Videos to a DVD

Operate on the Everio camera.

★ Depending on the model connected, the on-screen display may differ from those shown below.

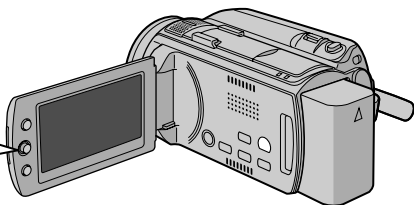
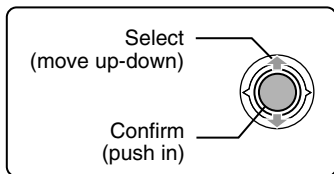

1 Select "CREATE FROM ALL"

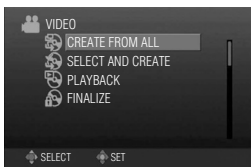

4 Select "Yes"

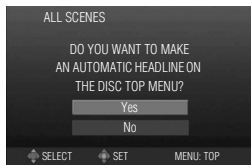

2 Select "ALL SCENES"

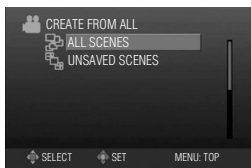

5 Select "EXECUTE"

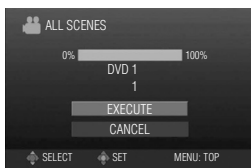

3 Select "OK"



6 Press "OK"

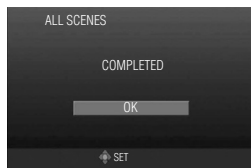

Copy completed!

- Do not turn off the power or remove the USB cable while the the hourglass or the copy in progress screen is displayed.

Note

You can also choose to copy your favourite scenes. For details, refer to the instruction manual of the Everio camera.

Playing Videos Stored on the DVD

1 Connect this burner to the TV

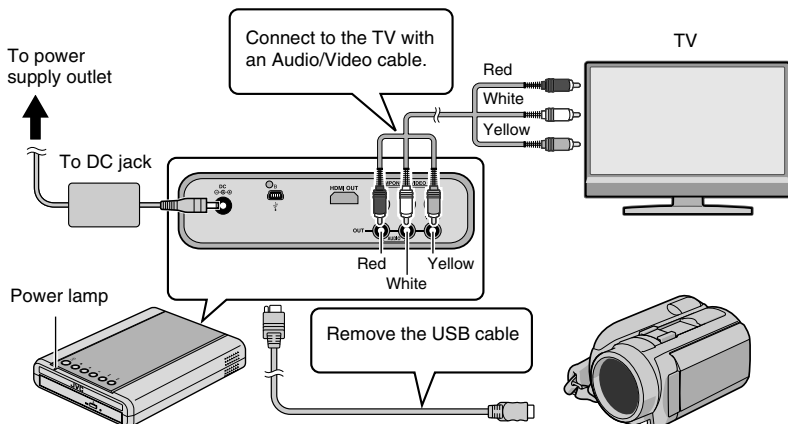

• For details, refer to "Connecting to the TV" (P.12, 13).

2 Remove the USB cable

- The power lamp on the burner changes as follows.
Green → Blinking orange → Orange
- When the USB cable is removed, the playback navigator appears automatically. (About 40 seconds.)

(Playback navigator screen on the TV)

Caution

- An unfinalised disc cannot be played back properly. Refer to the instruction manual of the Everio camera and finalise the disc.



3 Use the selection keys on the remote control to select the video to play back and press the ENTER button.

Playback begins!

- When the power lamp blinks slowly in red due to a drop in the burner's interior temperature, some functions will not work and there will be no image displayed on the TV screen. Wait until the power lamp stops blinking in red before operating this burner.

This burner enables DVDs of videos recorded with the JVC Hard Disk Camera to be created without using a PC.

- If you want to edit videos recorded with the camera and create your original DVDs, use the software provided with the camera for editing and creating DVDs.
- A provided data writing software Power2Go 5.5 Lite can be used for writing data. However, it cannot be used to edit videos or create DVDs.
- The burner does not include support for Macintosh.

Dear Customer,

Thank you for purchasing this burner. Before use, please read the safety information and precautions contained in pages 6 and 7 to ensure safe use of this product.

Safety Precautions

IMPORTANT:

In the event that any of the following occur, remove the plug and make a request for repair to the dealer.

- Smoke or abnormal odour is emitted
- Damage from being dropped
- Water or an object enters inside

CAUTION:

A UNIT IS A CLASS 1 LASER PRODUCT. HOWEVER THIS UNIT USES A VISIBLE LASER BEAM WHICH COULD CAUSE HAZARDOUS RADIATION EXPOSURE IF DIRECTED. BE SURE TO OPERATE THE UNIT CORRECTLY AS INSTRUCTED. WHEN THIS UNIT IS PLUGGED INTO THE WALL OUTLET, DO NOT PLACE YOUR EYES CLOSE TO THE OPENING OF THE DISC TRAY AND OTHER OPENINGS TO LOOK INTO THE INSIDE OF THIS UNIT. USE OF CONTROLS OR ADJUSTMENTS OR PERFORMANCE OF PROCEDURES OTHER THAN THOSE SPECIFIED HEREIN MAY RESULT IN HAZARDOUS RADIATION EXPOSURE. DO NOT OPEN COVERS AND DO NOT REPAIR YOURSELF. REFER SERVICING TO QUALIFIED PERSONNEL. CLASS 1 LASER PRODUCT REPRODUCTION OF LABELS WARNING LABEL INSIDE OF THE UNIT

CAUTION CLASS 3B VISIBLE AND INVISIBLE LASER RADIATION WHEN OPEN, AVOID EXPOSURE TO THE BEAM.
ATTENTION RADIATIONS LASER VISIBLES ET INVISIBLES DE CLASSE 3B QUAND OUVERT. ÉVITEZ TOUT EXPOSITION AU FAISCEAU.
ADVARSEL KLASSE 3B SYNLIG OG OSYNLIG LASERSTRÅLING VED ÅBNING. UNDGÅ UDSÆTTELSE FOR STRÅLING.
VARO! AVARTAISSA OLET ALTTIINA NÄKYVÄLLE JA NÄKYMÄTTÖMÄLLE LUOKAN 3B LASERSÄTEKYLLE. ÄLÄ KATSO SÄTEESEEN.
WARNING KLASSE 3B SYNLIG OCH OSYNLIG LASERSTRÅLNING NÄR DENNA DEL ÄR ÖPPNAD. UNDVÄR ATT UTSÄTTA DIG FÖR STRÅLEN. BEI BEEFFNETER ABECKUNG IST SICHTBARE UND UNSICHTBARE LASERSTRÄHLUNG DER KLASSE 3B IM GERÄTENÄHEREN VORHANDEN. NICHT DEM LASERSTRAHL AUSSETZEN!
VORSICHT CUANDO SE ABRE HAY RADIACIÓN LÁSER DE CLASE 3B VISIBLE E INVISIBLE. EVITE LA EXPOSICIÓN A LOS RAYOS LÁSER.
注意 ここを開くと CLASS 3B の可視レーザー光及び不可視レーザー光が出ます。ビームを直接見たり、触れたりしないこと。

This unit applies to the standard "IEC60825-1:2001" for laser products.

The socket-outlet shall be installed near the equipment and shall be easily accessible.

ATTENTION:

This unit contains microcomputers. External electronic noise or interference could cause malfunctioning. In such cases, switch the unit off and unplug the mains power cord. Then plug it in again and turn the unit on. Take out the disc. After checking the disc, operate the unit as usual.

CAUTION:

To avoid electric shock or damage to the unit, first firmly insert the small end of the power cord into the AC Adapter until it is no longer wobbly, and then plug the larger end of the power cord into an AC outlet.

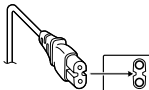

- The mains plug shall remain readily operable.
- Remove the mains plug immediately if the burner functions abnormally.

If malfunctioning occurs, stop using the unit immediately and consult your local JVC dealer.

Caution on Replaceable lithium battery

The battery used in this device may present a fire or chemical burn hazard if mistreated. Do not recharge, disassemble, heat above 100 °C or incinerate. Replace battery with Panasonic (Matsushita Electric), Sanyo, Sony or Maxell CR2025. Danger of explosion or Risk of fire if the battery is incorrectly replaced.

- Dispose of used battery promptly.
- Keep away from children.
- Do not disassemble and do not dispose of in fire.

WARNING:

Batteries shall not be exposed to excessive heat such as direct sunshine, fire or the like.

The I/O button does not completely shut off mains power from the unit, but switches operating current on and off. "O" shows electrical power standby and "I" shows ON.

Safety Precautions for the Burner

Be sure to observe the following precautions. Failing to do so may result in electric shock, fire, injury, or malfunction.

- Do not disassemble, dismantle, or modify the equipment. Requests for repair and inspection should be made to the dealer.
- Do not insert metal or combustible objects or pour water or other liquids inside the burner.
- Turn off the power when connecting equipment.
- Remove the plug when the burner will not be used for a prolonged time or prior to cleaning (electricity flows through the equipment even when the power is off).
- Do not block the ventilation holes of the burner.
- Do not use where there is condensation. Suddenly carrying the burner from a cold location to a hot location may result in the formation of drops, which may cause a malfunction or failure.
- Do not cause the burner to vibrate when discs are in.

Safety Precautions for Accessories

- When using the AC adapter, the power cord, and the USB cable, be sure to observe the following precautions. Failing to do so may result in electric shock, fire, injury, or malfunction.
 - Do not insert or remove the plug when your hands are wet.
 - Fully insert the plug into the outlet.
 - Keep dust and metal objects away from the plug.
 - Do not damage the cord.
 - Place the cord where it will not trip someone up.
 - Do not use when thunder can be heard.
 - Do not dismantle.
 - Do not use for any product other than this one.
- Do not play the provided CD-ROM with an audio player. Doing so may damage the circuits or speakers.

Safety Precautions for Discs

Do not use the following discs.

- Cracked discs
- Deeply scratched discs

Installation

Do not install in any of the following locations.

- Humid location
- Location of 60 °C or above
- Location subject to direct sunlight
- Location where overheating is likely
- Dusty or smoky locations
- Locations subject to oily smoke or steam such as a kitchen counter or beside a humidifier
- Unstable location
- Bathroom
- Dusty places
- Slanted location

ATTENTION:

On placing the unit:

Some TVs or other appliances generate strong magnetic fields. Do not place such appliances on top of the unit as it may cause picture disturbance.

When moving the product:

Press I/O to turn off the power, and wait at least 30 seconds before unplugging the power cord. Then, wait at least 2 minutes before moving the product.

Contents

● Safety Precautions	6
● Getting Started.....	9
Accessories	9
Placing the Burner.....	9
● Names and Functions of Each Part	10
Front and Top Panel.....	10
Rear Panel.....	10
Remote Control	11
● Connecting to the TV	12
Connecting to a TV with HDMI Input Terminal	12
Connecting to a TV with Component Video Input Connectors	13
Connecting to a TV with Audio/Video Input Connectors.....	13
● Copying Everio Video to a DVD	14
Connecting to an Everio Camera	14
Creating AVCHD Disc/Data Disc/DVD-Video.....	15
● Copying from PC to DVD	16
Connecting to a PC	16
Copying to a DVD.....	16
Computers That Can Be Used	17
Installing CyberLink Power2Go 5.5 Lite	18
CyberLink Power2Go 5.5 Lite Contact Information	20
● Folder Configuration	21
When Copying from High Definition Everio to Data Disc.....	21
When Copying from High Definition Everio to AVCHD Disc.....	22
When Creating and Storing Desired Folders and Files on a PC	22
● Playing Images Stored on the DVD.....	23
Viewing Images Copied from the High Definition Everio	23
Viewing DVD-Video Copied from Everio	27
● Changing the Playback Settings.....	29
● Operate in Conjunction with TV via HDMI.....	31
● Viewing High Quality Images	33
● Settings Menu	34
Menu Operation Procedures	34
Settings Menu Items and Descriptions	35
● Screen Displays.....	39
● Troubleshooting	41
● Error Messages.....	45
● Other Information	46
● Specifications	48

Getting Started

Accessories

If there are any items missing, please consult your authorised dealer.

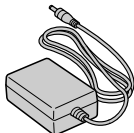

AC adapter
(AP-V50U)



Power cord

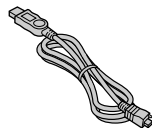

USB cable
Mini A – Mini B type

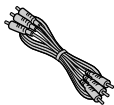

Audio/Video cable

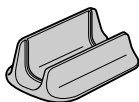

Stand



Remote control
(RM-V55U)



DVD-R (blank disc) x 1
CD-ROM (data writing
software) x 1

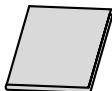

Instruction manual
(this manual), other
printed material



Do not use the provided AC adapter and power cord for other devices. In addition, do not use AC adapter and power cord other than those provided with this burner. Doing so may result in electric shock or fire.

Placing the Burner

■ Horizontal orientation

Take note of the top and bottom of the burner and place it in the horizontal orientation.

■ Vertical orientation

Align the groove on the bottom of this burner with the bulge on the stand and fix the burner securely on the stand.

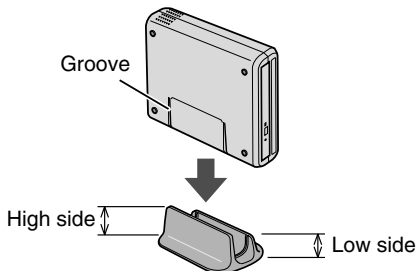

Names and Functions of Each Part

Front and Top Panel

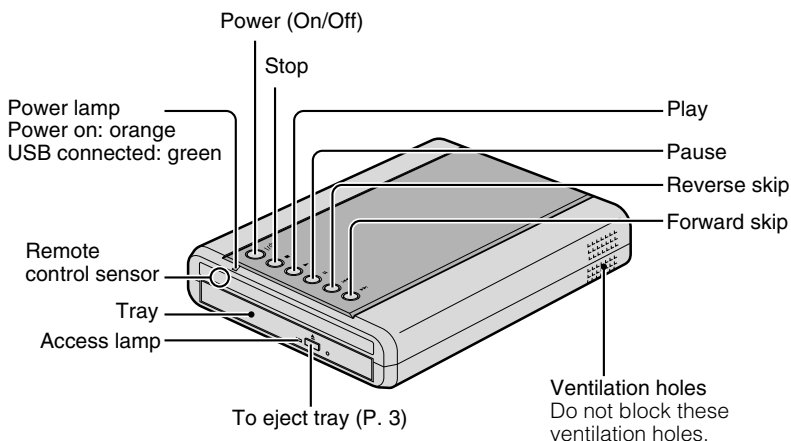

Rear Panel

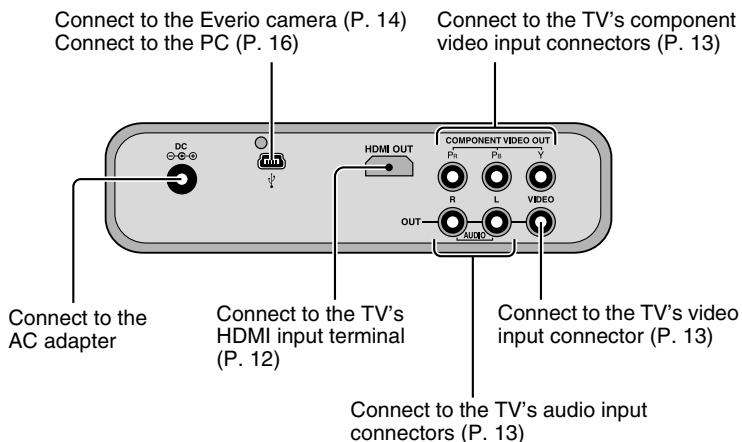

Remote Control

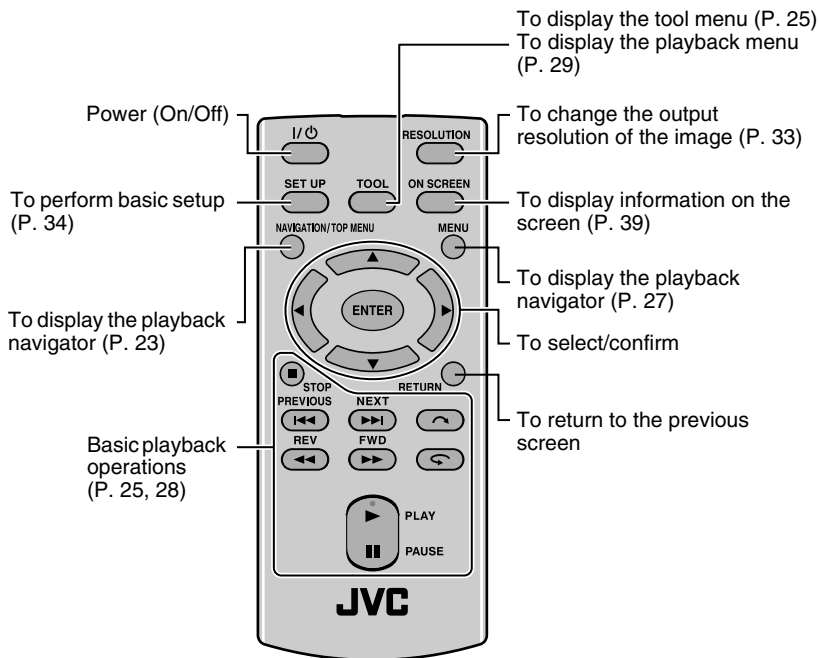

Note

- If the burner responds poorly to the remote control, the battery of the remote control is weak. Replace it with a new battery. Insert correctly according to the ⊕ and ⊖ directions indicated.
- If problem occurs while using the remote control, remove the battery and insert it again before operating the remote control.

■ When using the remote control for the first time

Pull out the insulation sheet

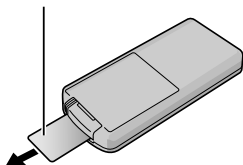

■ When replacing the battery

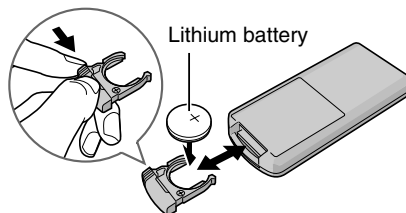

Connecting to the TV

Connecting to a TV with HDMI Input Terminal

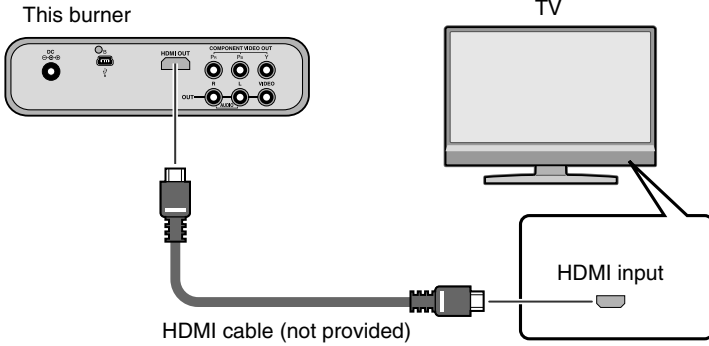

Note

- Images can only be displayed on a High-bandwidth Digital Content Protection (HDCP) monitor.
- We recommend using the Category 2 HDMI cable (High Speed cable) for viewing in higher picture quality.

Connecting to a TV with Component Video Input Connectors

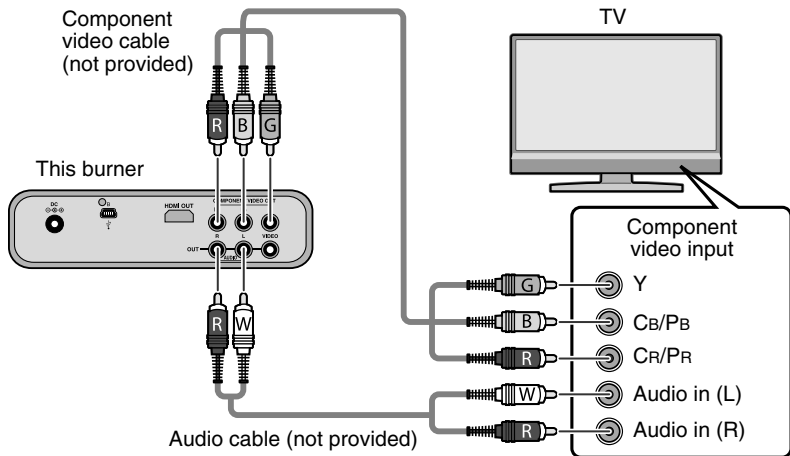

Note

- Connect to a High-bandwidth Digital Content Protection (HDCP) monitor when using an HDMI-DVI conversion cable.

Connecting to a TV with Audio/Video Input Connectors

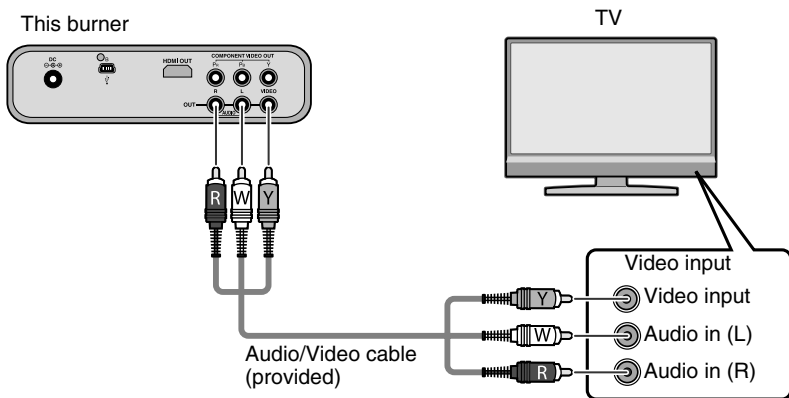

Copying Everio Video to a DVD

By connecting this burner to an Everio camera, you can easily copy recorded images to a DVD.

Connecting to an Everio Camera

- Preparations
- Everio: Off
 - This burner: Off

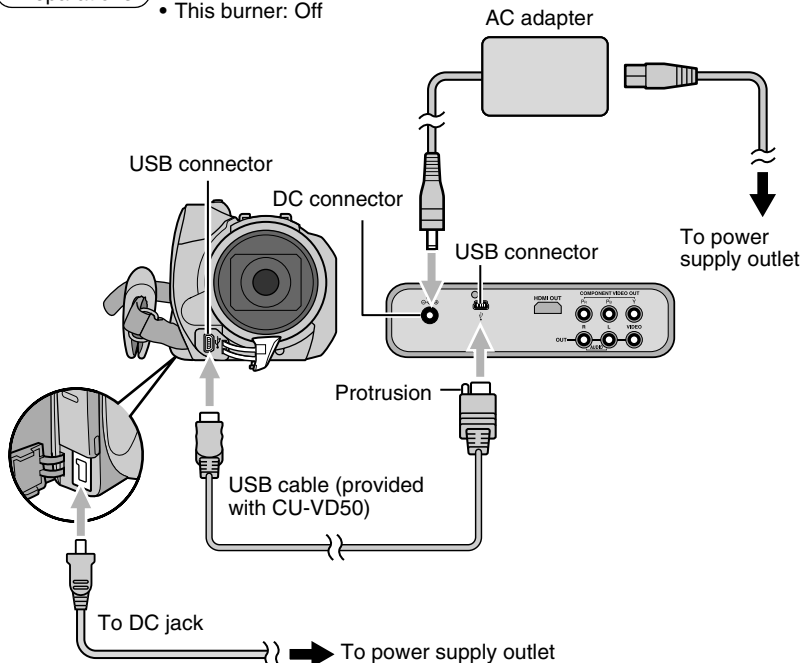

Note

- When the USB cable is connected, all buttons on the remote control of this burner are not functional except the power button.



Creating AVCHD Disc/Data Disc/DVD-Video

■ Discs that can be created on this burner

	Copy	Playback
AVCHD Disc	High definition videos in AVCHD format.	Can be played back on AVCHD-compatible devices (such as Blu-ray recorder) or this burner. (P. 23)
Data Disc	High definition videos in MPEG-2 format.	Play back on this burner. (P. 23) Cannot be played back on other devices.
DVD-Video	Standard definition videos in MPEG-2 format.	Can be played back on DVD recorder, DVD player or this burner. (P. 27)

- High definition Everio GZ-HD30/HD40 supports both AVCHD and MPEG-2 format recording. Other high definition Everio supports MPEG-2 format recording. (As of May 2008.)

Preparations

- Mode switch on Everio:
 or  mode (depending on the item to be copied)
- This burner: On

1 Turn on Everio

- The Backup menu will appear on the Everio's LCD monitor.

2 Insert a new disc

- Refer to page 3 on how to insert the disc.
- Refer to page 2 for the recommended discs.

3 Create a AVCHD disc, data disc or DVD-Video

- Refer to the instruction manual of your Everio camera on how to create a AVCHD disc, data disc or DVD-Video.

Note

- Depending on the model connected, still images cannot be copied. For details, refer to the instruction manual of the Everio camera.
- Do not turn off this burner while data is being written to the disc. The disc cannot be ejected during data writing. Wait until writing finishes.
- The remote control is not operable when this burner is connected to the Everio.

Copying from PC to DVD

This burner can be used as a DVD burner when connected to a PC. And you can use the provided software to copy to a DVD.

Connecting to a PC

Preparations

- Everio: Off
- This burner: Off

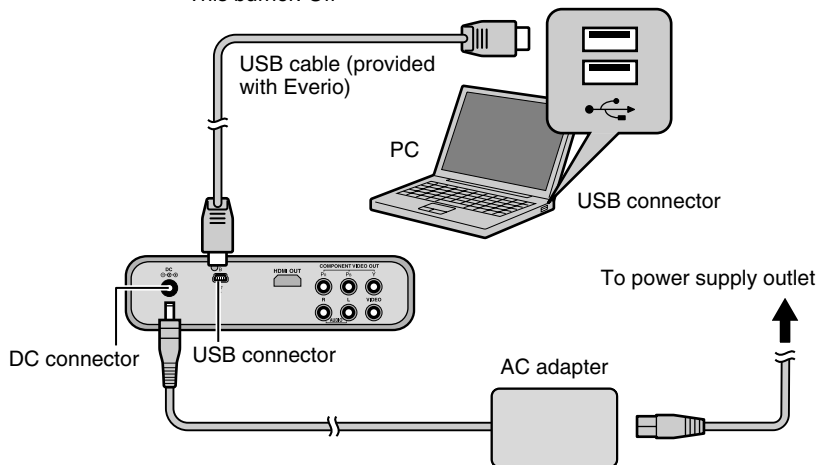

Copying to a DVD

1 Turn on this burner and the PC

- Install the CyberLink Power2Go 5.5 Lite software if you have not done so. (P. 18)

2 Insert a new disc

- Refer to page 3 on how to insert the disc.
- Refer to page 2 for the recommended discs.

3 Use Power2Go to copy to a DVD

- ① Use Power2Go to create a folder.
 - Use half-width alphanumeric characters when entering the folder names or file names. You can enter up to 40 characters.
- ② Under the “Burner” tab in the Power2Go “Configuration/Information” menu, check the box next to “Close disc”. Confirm that the file system under the data tab is set to “UDF 1.5”. Video playback will not function properly if the disc was created with the file system set to “ISO9660/Joliet”.
- ③ Copy files such as JTS, TPD and JPG into the folder.

Note

- For details on using Power2Go, refer to the User's guide, Help and Readme files installed with the software. You can access the User's guide, Help and Readme files from the Start menu on the PC.
- To get customer support and to register the software, you need the following product key (CD-Key):
PXNVM-NWE4G-XQD9Q-CU9DX-3FQFN-NAKUS
- This burner cannot be used to write files into CD-R or CD-RW discs. Refer to page 51 for the recommended discs.
- This burner does not response to all the functions of Power2Go 5.5 Lite.
- Power2Go 5.5 Lite does not support conversion of audio files to MP3 format.
- When the "Enter Activation Key" screen appears while using Power2Go 5.5 Lite, close the screen without entering the activation key.

■ Removing USB cable from PC

- ① Carry out removing of hardware on the PC.
- ② Remove the USB cable.

Caution

- To play back disc created on a PC on this burner, follow the following procedure.
Insert the disc into this burner. After disc recognition, press the NAVIGATION/TOP MENU button to display the playback navigator. (P. 23)
- For data disc created on a PC, the date and time displayed will not be accurate.

Computers That Can Be Used

CyberLink Power2Go 5.5 Lite can be used on computers satisfying the following conditions.

Operating system	Windows® XP Home Edition (pre-installed) Windows® XP Professional (pre-installed) Windows Vista™ Home Basic (32-bit edition, pre-installed) Windows Vista™ Home Premium (32-bit edition, pre-installed)
Connector	USB 2.0/1.1 connector (*)
CPU	Intel® Pentium® III, at least 800 MHz (Intel® Pentium® 4, at least 2 GHz recommended)
RAM	At least 128 MB (at least 256 MB recommended)
Free hard disk space	At least 50 MB for installation At least 5 GB recommended for creating DVDs
Display	Must be capable of displaying 800 x 600 dots

* If you use USB 1.1 cable, it will take approximately 3 hours to write one DVD.

Installing CyberLink Power2Go 5.5 Lite

Caution

- Do not play the provided CD-ROM in an audio player. It is not an audio CD. Playing this CD-ROM in an audio player will result in a loud high noise. It may also damage the circuit and speaker.

1 Insert the provided CD-ROM in the PC

Windows Vista:

- ① Click “Run INSTALL.EXE” on the “AutoPlay” screen.
- ② Click “Continue” on the “User Account Control” screen.
- ③ The “Choose Setup Language” screen appears.

Windows XP:

- After a while, the “Choose Setup Language” screen appears.

2 Confirm the language and then click “OK”

- The following screen appears.



3 Click “Next”

- The “License Agreement” screen appears.

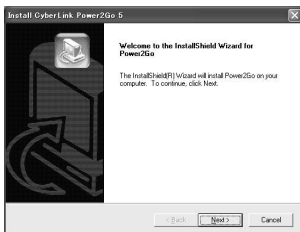

4 Confirm the contents and then click “Yes”

- The “Customer Information” screen appears.

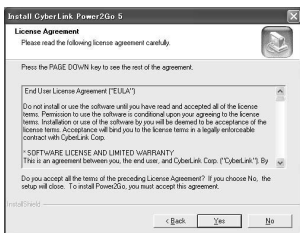

5 Enter the “User Name” and “Company Name” and then click “Next”

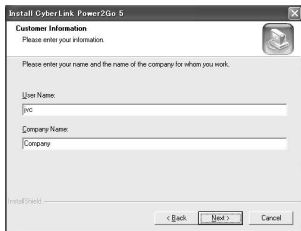

6 Follow the on-screen instructions

- Installation starts.
After a while, the “InstallShield Wizard Complete” screen appears.

7 Click “Finish”

- The computer will restart and installation is completed.
- If the screen on the right does not appear, proceed to step 8.



8 Click “Finish”

- The “CyberLink Power2Go 5.5” Readme screen appears.



9 Read the contents of the Readme

CyberLink Power2Go 5.5 Lite Contact Information

For information on CyberLink Power2Go 5.5 Lite or other products, use the following contact information.

■ Telephone/fax support

Location	Language	Office hours (Mon. to Fri.)	Phone #	Fax #
Germany	English / German / French / Spanish / Italian	9:00 am to 5:00 pm	+49-700-462-92375	+49-241-70525-25
Taiwan	Mandarin	9:00 am to 6:00 pm	+886-2-8667-1298 ext. 333	+886-2-8667-1300
Japan	Japanese	10:00 am to 5:00 pm	+81-3-3516-9555	-

■ Paid voice support

Location	Language	Lines are open (Mon. to Fri.)	URL
U.S.A.	English	1:00 pm to 10:00 pm CST	http://www.cyberlink.com/english/cs/support/new_site/voice_support.jsp

■ Support web/e-mail

Language	URL/e-mail address
English	http://www.cyberlink.com/english/cs/support/new_site/support_index.html
German / French / Spanish / Italian	goCyberlink@aixtema.de
Japanese	http://jp.cyberlink.com/support/

Folder Configuration

This shows the folder configuration when files are copied from a high definition Everio camera or a PC to a DVD.

When Copying from High Definition Everio to Data Disc

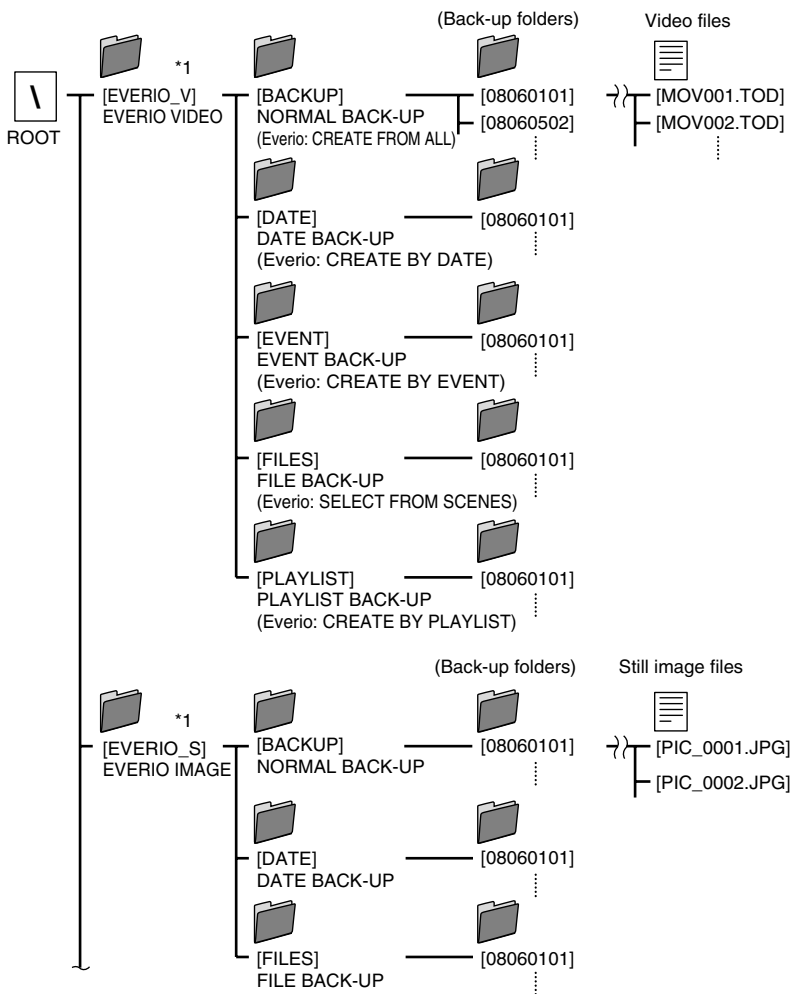

*1 Video and still image files recorded on a high definition Everio camera that are copied to this burner will be stored in the "EVERIO_V" and "EVERIO_S" folders.

When Copying from High Definition Everio to AVCHD Disc

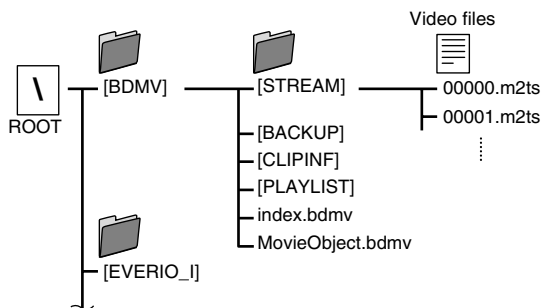

When Creating and Storing Desired Folders and Files on a PC

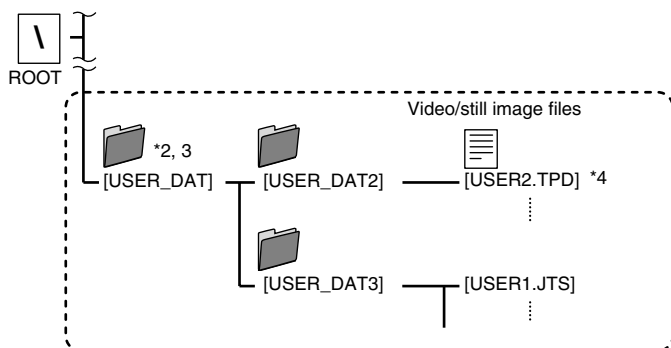

*2 Create folders with Power2Go and copy the desired video and/or still image files into the folders. You can use any folder names and file names according to your preference. (Indicated as “USER_DAT” in the illustration.)

*3 Use Power2Go to copy the “USER_DAT” folders to the DVD. (P. 16)

*4 Files with the extension “.TPD” or “.JTS” are high definition Everio video files edited on the PC.

- Refer also to “Data format (extension)” (P. 49).

Caution

- You can create folders and files with any names according to your preference; however do not use “EVERIO_V” or “EVERIO_S” as the folder name.
- Use half-width alphanumeric characters when entering the folder names or file names. You can enter up to 40 characters.
- You can create up to 6 levels of folders. Playback is not possible if more than 6 levels are created.
- The total path length of the file is up to 240 characters.

Playing Images Stored on the DVD

You can play back video and still images of Everio stored on a DVD.

Viewing Images Copied from the High Definition Everio

■ To start viewing immediately after storing images on a DVD

- ① Remove the USB cable. (P. 14)
- ② Connect this burner to the TV.
 - For details on connection, refer to “Connecting to the TV” (P. 12, 13).
 - Check that the power lamp of this burner lights up in orange.
 - After pressing the power button, it will take about 25 seconds to display the intermediate screen. (P. 34)

1 Insert the disc containing the copied images and the playback navigator will appear

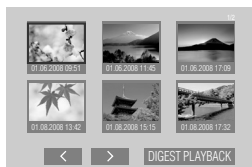

AVCHD disc



Data disc (video images)



Data disc (still images)

- It will take about 40 seconds to display the playback navigator.
- To alternate between video and still images on a disc that contains video and still images, switch using the TOOL MENU. (P. 25)
- For data disc (video), the file being selected is played back on its thumbnail. (Motion thumbnail) It will take several seconds to display all the eight thumbnails. And a little bit more time to show the motion thumbnail.
- The menu displayed may differ from the menu shown above when an AVCHD disc created on other devices is inserted.

2 Select and confirm on the file using the remote control

- ① Select

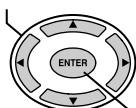

- ② Confirm

- Playback of the selected file starts.
- You can also press the PLAY button to play back.
- You can browse the pages using the PREVIOUS / NEXT (◀▶) buttons.

Note

- To stop an AVCHD disc during playback, press the STOP button. When playback stops, the intermediate screen will appear. (P. 34)
To display the playback navigator, press the NAVIGATION/TOP MENU button.

■ Digest Playback (for AVCHD disc only)

- Use the selection keys to select "DIGEST PLAYBACK" and press the ENTER button. The videos will be played back for several seconds consecutively.
- Press the NAVIGATION/TOP MENU button during playback to display the sub menu.

TO NORMAL PLAYBACK : Plays back the video normally.

TO INDEX MENU : Returns to the playback navigator screen.

■ To play back images in a different folder [for data disc (video/still images) only]

1 Display the folder list

① Select folder name

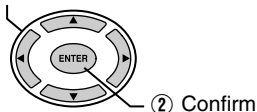

Folder Name



2 Select the folder to play back

- The playback navigator appears when the ENTER button is pressed. Select and confirm on the file to be played back.

① Select

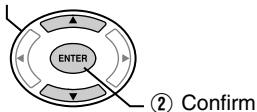

- You can also select the folder from the "TOOL MENU" (P. 25).
- Files are automatically sorted into the folders created depending on the item selected in the Backup menu of the high definition Everio.
- To play back images copied from the PC, select the edited video files. (P. 22)
- Select a folder name when you have created a folder on the PC according to your preference. (P. 22)

Caution

- If images do not appear, check the resolution setting. (P. 33)
- For short video clips (less than 3 seconds), the image will freeze for a few seconds before playing the next file. (P. 44)
- For data disc (video), the image will freeze for a few seconds before continuing to the next folder.

Note

- Depending on the still image standards, some images are displayed using a "?" thumbnail, and playback may fail in this case.
- Progressive JPEG files and special files created on the PC cannot be played back. Videos that are not playable are also displayed as "?".
- It may take some time to display the images if the size is too large or when there are too many files.
- For data disc (still images) created on a PC, files with less than 640 x 480 resolution will not be displayed in full screen.

■ Displaying the TOOL MENU [for data disc (video/still images) only]

You can switch between video/still images or display file details from the TOOL MENU.

Operate when playback navigator is displayed

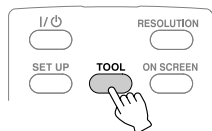

① Select

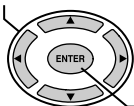

② Confirm







Select an item with the selection keys and press the ENTER button.









- **FOLDER SELECT:** Displays the folder list.
- **SWITCH TO IMAGE MODE :** Switches from video to still image.
(**SWITCH TO VIDEO MODE:** Switches from still image to video.)
- **SHOW DETAIL:** Displays the file name, folder name, recorded date, and playback duration (for video) or image size (for still image). The playback duration display for video will not be available if the file has not been played back before.

Note

- When the disc contains both videos and still images, the videos will be displayed first. To view still images, select "SWITCH TO IMAGE MODE" from the TOOL MENU.

■ Buttons that can be used during playback (AVCHD / data disc)

Remote Control Button		Description	
		Video Image Playback	Still Image Playback
	PLAY	Pressing this button when in the paused or variable speed playback mode resumes normal playback.	Starts the slide show.
	PAUSE	Pauses playback.	Pauses the slide show.
	STOP	Stops playback.	Stops the slide show.
	FWD	Fast-forwards playback. Changes in the order of Search +1 to Search +3 with each press. Press the button when in the paused mode to enable forward playback frame by frame. Press and hold the button to slow down the playback speed. Pressing the button each time changes the playback speed between 1/16x, 1/4x, and 1/2x.	—

Remote Control Button		Description	
		Video Image Playback	Still Image Playback
	REV	Rewinds playback. Changes in the order of Search -1 to Search -3 with each press. Press the button when in the paused mode to enable reverse playback frame by frame. (Not available for AVCHD disc.) Reverse playback at slow speed is not possible.	—
	NEXT	Displays the next video image.	Displays the next still image.
	PREVIOUS	Displays the beginning of the video image.	Displays the previous still image.
	Skip	Advances the playback position by about 30 seconds.	Rotates the still image by 90 degrees in the clockwise direction. (When in paused mode.)
	Replay	Moves the playback position backward by about 7 seconds.	Rotates the still image by 90 degrees in the anti-clockwise direction. (When in paused mode.)
	ENTER	—	Enlarges the still image. (2-step) You can select the position to enlarge using the Up/Down/Left/Right buttons. Press the RETURN button to restore the original size. (When in paused mode.)
	NAVIGATION /TOP MENU	Displays the playback navigator.	Displays the playback navigator.
	TOOL	Displays the playback menu. (P. 29)	Displays the playback menu. (P. 29)

Viewing DVD-Video Copied from Everio

■ To start viewing immediately after storing images on a DVD

- ① Remove the USB cable. (P. 14)
- ② Connect this burner to the TV.
 - For details on connection, refer to “Connecting to the TV” (P. 12, 13).
 - Check that the power lamp of this burner lights up in orange.
 - After pressing the power button, it will take about 25 seconds to display the intermediate screen. (P. 34)

■ To play back the copied files

① Insert the disc containing the copied images

- Playback starts automatically.

■ To select and play back a desired file

① Insert the disc containing the copied images

- Playback starts automatically.

② During playback, press the NAVIGATION/TOP MENU button to display the playback navigator

- Depending on the disc, you can display the playback navigator by pressing the MENU button.

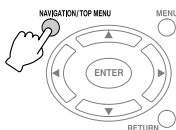

③ Select and confirm on the file to play back

① Select

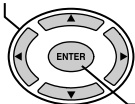

② Confirm











Note

- To stop playback, press the STOP button. When playback stops, the intermediate screen will appear. (P. 34)
To display the playback navigator, press the NAVIGATION/TOP MENU button.

Caution

- If images do not appear, check the resolution setting. (P. 33)

■ Buttons that can be used during playback (DVD-Video)

Remote Control Button		Description
 PLAY	PLAY	Pressing this button when in the paused or variable speed playback mode resumes normal playback.
 PAUSE	PAUSE	Pauses playback.
 STOP	STOP	Stops playback.
 FWD	FWD	Fast-forwards playback. Changes in the order of Search +1 to Search +3 with each press. Press the button when in the paused mode to enable forward playback frame by frame. Press and hold the button to slow down the playback speed. Pressing the button each time changes the playback speed between 1/16x, 1/4x, and 1/2x.
 REV	REV	Rewinds playback. Changes in the order of Search -1 to Search -3 with each press. Press the button when in the paused mode to enable reverse playback frame by frame. Press and hold the button to slow down the reverse playback speed. Pressing the button each time changes the reverse playback speed between -1/16x and -1/4x.
 NEXT	NEXT	Displays the next video.
 PREVIOUS	PREVIOUS	Displays the previous video.
	Skip	Advances the playback position by about 30 seconds.
	Replay	Moves the playback position backward by about 7 seconds.
	TOOL	Displays the playback menu. (P. 29)

Changing the Playback Settings

You can alter the method for playing back video/still images as well as the image settings.

Operate during playback

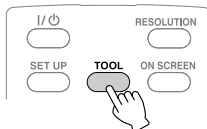

 indicates the default settings during purchase of this product.

DISC SETTING

If the disc contains more than one audio language, subtitle language or has multi-angle scenes, you can select with this setting.

AUDIO LANGUAGE	Set the audio language to be played back.
SUBTITLE	Set the subtitle language to be displayed.
CHANGE ANGLE	Switch the angle (camera) to be played back.

PLAYBACK SETTING

REPEAT	
For configuring settings on video playback and repeat playback of slide shows.	
OFF	Do not repeat.
TITLE	Repeats playback of the title. (For video images only.)
CHAPTER	Repeats playback between the chapters. (For AVCHD discs and DVD-Videos only.)
FOLDER	Repeats playback of files within a folder. (For files stored on the PC only.)
ALL	Repeats playback of all files*. (For data disc stored on high definition Everio only.) * The files in the current folder are played back repeatedly when you play back from the playback navigator.
A-B	Repeats playback between two predetermined points A and B. (For DVD-Videos only.)
CHANGE TITLE (For AVCHD discs and DVD-Videos only)	
Jumps to the specified title.	
CHANGE CHAPTER (For AVCHD discs and DVD-Videos only)	
Jumps to the specified chapter.	
SLIDESHOW INTERVAL (For still images only)	
5 SEC / 10 SEC / 15 SEC	For specifying the time for displaying images.
SLIDESHOW EFFECTS (For still images only)	
For specifying the fade effect when switching to another image.	
OFF	Disable fade effect.
ON	Enable fade-in or fade-out from black colour.

VIDEO SETTING**You can only configure settings for video images.**

PICTURE QUALITY	
For specifying the video image quality.	
NORMAL	Set to this value under normal circumstances.
CINEMA	Plays back in cinema-like picture quality.
FINE	Plays back in clear sharply defined picture quality.
SOFT	Plays back in soft textured picture quality.
USER SETTING	Plays back images in the picture quality specified in "DETAIL SETTING".
DIGITAL NOISE REDUCTION	
For specifying whether to enable noise removal from the image.	
OFF	Disable noise removal.
ON	Enable noise removal.
DETAIL SETTING	
For specifying the advanced settings when "PICTURE QUALITY" is set to "USER SETTING".	
CONTRAST	For specifying the image contrast level.
BRIGHTNESS	For specifying the image brightness level.
SHARPNESS	For specifying the image contour.
COLOR	For specifying the colour intensity of the image.
GAMMA	For specifying the image gray level.
3DNR	For specifying the image noise reduction.
PROGRESSIVE OUTPUT	
For playing back the source material after converting to an appropriate progressive video.	
AUTO1	Automatically detects the film material and video material and converts to the appropriate progressive video.
AUTO2	In addition to "AUTO1", automatically detects the 30fps progressive video and converts to the appropriate progressive video.
VIDEO	Converts the video material to the appropriate progressive video.

Note • Changing the setting may have no effect on some images.

Operate in Conjunction with TV via HDMI

Connecting this burner to an HDMI-CEC-enabled TV using the HDMI cable allows you to utilise the following convenient functions.

Preparations

- Connect an HDMI cable between this burner and the TV. (P. 12)
- Turn on the TV and set the HDMI-CEC related setting in its menu to “on”. (For details, refer to the instruction manual of the TV.)
- Turn on this burner and set “CONTROL WITH HDMI” under “CONNECTION SETTING” in the settings menu to “ON”. (P. 34, 37)

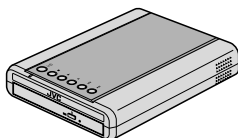

HDMI cable (not provided)

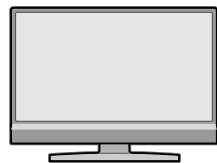

Operation method 1

- Insert a disc.
(Press the PLAY or NAVIGATION/TOP MENU button if the playback navigator does not appear.)



- The TV automatically switches to the HDMI input.
(Turn on the TV beforehand.)

Operation method 2

- This burner turns off automatically.



- Turn off the TV.

Note

- Some TV will turn on automatically and switch to the HDMI input just by turning on this burner.
- Depending on the TV connected, the onscreen display language of this burner will automatically switched to the language that was being selected for the TV when the burner is turned on.
(This is applicable only if this burner supports the language selected for the TV.)
To use this burner using a language that differs from the onscreen display language of the TV, set “CONTROL WITH HDMI” to “OFF”.
- Malfunction may occur when devices such as amplifier and selector are connected. Set “CONTROL WITH HDMI” to “OFF”.

Note

- HDMI-CEC (Consumer Electronics Control) is an industry standard that enables interoperability between HDMI-CEC compliant devices that are connected via HDMI cables.
- Not all HDMI-compatible devices comply with the HDMI-CEC standard. The HDMI control function of this burner will not work when connected to these devices.
- This burner is not guaranteed to operate with all HDMI-CEC-enabled devices.
- Depending on the specifications of each HDMI-CEC-enabled device, some functions may not work with this burner. (For details, refer to the instruction manual of your TV.)
- Unintended operations may occur with some connected devices. In these cases, set "CONTROL WITH HDMI" to "OFF".

Caution

- HDMI control does not function when the USB cable is connected. Remove the USB cable if you want to use the HDMI control function.
- HDMI control does not function immediately after inserting the power cord to the AC outlet. Press the power button on this burner to turn it on.
- If the HDMI cable connection is changed, perform the following operations to allow this burner and the connected devices to recognise each other.
 - ① With the TV turned on, turn off and on this burner again.
 - ② Set the "CONTROL WITH HDMI" under "CONNECTION SETTING" in the settings menu to "OFF", then set to "ON" again.

Viewing High Quality Images

You can change the video output resolution when this burner is connected to a high definition TV using a HDMI or component video cable.

Operate when in the intermediate screen*

(Intermediate screen)

* To display the intermediate screen, refer to page 34.

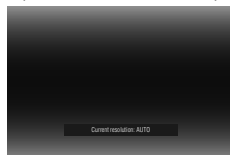
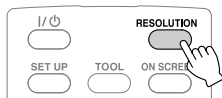

- Press the button each time to change the output resolution.

■ Connection using HDMI cable (“HDMI VIDEO MODE” : “ON”) (Resolutions not supported by the TV are not displayed.)

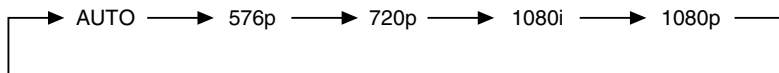

■ Connection using component video cable (“HDMI VIDEO MODE” : “OFF”, HDMI cable not connected)

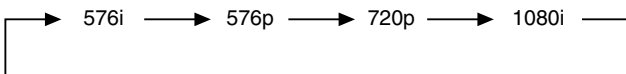

■ Connection using video cable

Setting is not necessary. “576i” is output regardless of the setting.

Caution

- If this burner is connected to a TV that does not support the preset output resolution using a HDMI cable, the setting switches automatically to “AUTO”.
- When this burner is connected using a component video cable with the output resolution set to “1080i” or “720p”, the output resolution will be set to “576i” or “576p” if a DVD-Video disc is inserted.

Note

- When the HDMI cable is connected, the resolution of the component connectors is fixed at “576i”. (“HDMI VIDEO MODE” : “ON”)
- When the resolution is set to “576p” for the HDMI cable connection, the “4:3 PAN&SCAN” or “4:3 LETTERBOX” display format under “MONITOR TYPE” in the settings menu will be selected if the image size is 4:3. (P. 35)
- For NTSC system, “576i” and “576p” are displayed as “480i” and “480p” respectively.

Settings Menu

Change the settings of this burner according to the environment of use.

Menu Operation Procedures

Caution

- The SET UP button can only function when the intermediate screen (screen without image display) is displayed. If the playback navigator is displayed, press STOP (for AVCHD disc and DVD-Video) or NAVIGATION/TOP MENU (for data disc) to clear the screen.

Example: When changing "MONITOR TYPE" under "CONNECTION SETTING" from "16:9" to "4:3 LETTERBOX"

1 Display the settings menu

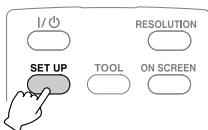

2 Select "CONNECTION SETTING"

① Select

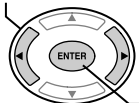

② Confirm



3 Select "MONITOR TYPE"

① Select

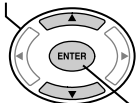

② Confirm



4 Select "4:3 LETTERBOX"

① Select

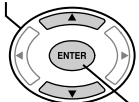

② Confirm



5 Close the settings menu

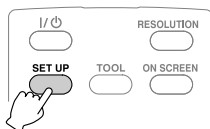

Settings Menu Items and Descriptions

 indicates the default settings during purchase of this product.

★ Menu items for which setting cannot be changed will appear grayed out on the screen.

DISC SETTING

If the disc contains more than one audio language, subtitle language or has multi-angle scenes, you can select with this setting.

AUDIO LANGUAGE	Set the audio language to be played back.
SUBTITLE	Set the subtitle language to be displayed.
CHANGE ANGLE	Switch the angle (camera) to be played back.

VIDEO SETTING

BLACK LEVEL CONTROL

For specifying the black level of the video image.

DARKER	Set to this value under normal circumstances.
BRIGHTER	Set to this value to brighten the dark areas of the video image.

AUDIO SETTING

DYNAMIC RANGE COMPRESSION

For specifying the dynamic range (ratio between strong and weak signals) of audio sound. Minute sounds may be heard when the dynamic range is compressed.

ON	Outputs audio sound after compressing the dynamic range.
OFF	Outputs the recorded audio sound without compressing.

CONNECTION SETTING

MONITOR TYPE

Specify the screen size according to the TV connected. (If the screen size of the TV is fixed, images displayed on the TV will not change even if you change the settings of the burner.)

16:9	When connecting to a wide-screen TV (16:9) (A black band will appear on both left and right sides for 4:3 images.)
16:9FULL	When connecting to a wide-screen TV (16:9) (4:3 images will be stretched sideways.)
4:3 PAN&SCAN	When connecting to a 4:3 TV (The left and right sides of 16:9 images will be missing.)
4:3 LETTERBOX	When connecting to a 4:3 TV (A black band will appear at the top and bottom for 16:9 images.)

Note • Changing the setting may have no effect on some images.

CONNECTION SETTING

COMPONENT OUTPUT	
For specifying the output resolution setting of the component connectors. You can also specify the setting using the remote control. (P. 33)	
576i*	During output in D1 (576i)
576p*	During output in D2 (576p)
720p	During output in D3 (1080i)
1080i	During output in D4 (720p)
HDMI SETTING	
HDMI VIDEO MODE	
Specify this setting when you are using the burner with both the HDMI terminal and component connectors connected.	
ON	Outputs with priority given to the HDMI terminal.
OFF	Outputs with priority given to the component connectors.
HDMI OUTPUT	
For specifying the output resolution setting of the HDMI terminal. You can also specify the setting using the remote control. (P. 33)	
AUTO	Set to this value under normal circumstances.
576p*	During output in D2 (576p)
720p	During output in D3 (1080i)
1080i	During output in D4 (720p)
1080p	During output in D5 (1080p) (P. 12)
24p OUTPUT	
JVC camcorders do not support 1080/24p recording. (As of May 2008.) Specify this setting when viewing video images recorded by other devices in 1080/24p on a TV that supports 1080/24p via HDMI connection.	
AUTO	Select this value to output the images in 1080/24p to a TV that supports 1080/24p. Set to "OFF" if the images cannot be played back properly.
OFF	Set to this value under normal circumstances.
x.v.Color	
Specify this setting when viewing video images recorded in x.v.Color on a TV that supports x.v.Color. This enhances viewing through reproducing colours closely to their natural colours.	
AUTO	Set to this value under normal circumstances.
OFF	Set to this value when the video images are distorted or when the colours are not correctly reproduced.

* For NTSC system, "576i" and "576p" are displayed as "480i" and "480p" respectively.

Deep Color	
	This function works during playback. Specify this setting when viewing images on a TV that supports Deep Color. This allows viewing of high definition images of 30-bit and 36-bit colour depths that are higher than the full 24-bit colour.
AUTO	Select this value to view high definition images on a TV that supports Deep Colour. Set to "OFF" if the images cannot be played back properly.
OFF	Set to this value under normal circumstances.
HDMI ENHANCE SETTING	
	Specify this setting when connected to a TV that comes with the DVI input terminal using an HDMI-DVI conversion cable.
STANDARD	Set to this value under normal circumstances.
ENHANCED	Set to this value when the black and white colours of the video image are not clear.
CONTROL WITH HDMI	
	For specifying whether to use the HDMI-CEC function which allows the TV to operate in conjunction with this burner. (P. 31)
OFF	Do not operate in conjunction with TV.
ON	Operate in conjunction with TV.

OTHER SETTING

RESUME *	
For specifying whether to memorise the stop position.	
ON	Memorise the stop position.
OFF	Do not memorise the stop position.
ON SCREEN GUIDE	
For specifying whether to display the playback status information.	
AUTO	Display for 5 seconds.
OFF	Do not display.
ON SCREEN LANGUAGE	
For specifying the language to be displayed for the settings menu screen and others. "ENGLISH" is set as the default language. (日本語 / ENGLISH / FRANÇIAS / DEUTSCH / ITALIANO / NEDERLANDS / PORTUGUÊS / ESPAÑOL / 汉语 / 中文 / 한국어 / РУССКИЙ)	
SCREEN SAVER	
For specifying whether to activate the screensaver.	
ON	Activates the screensaver when this burner is not operated for an interval of 5 minutes.
OFF	Do not activate the screensaver.
INITIALIZE SETTING	
Restores the settings to the default state at the time of purchase.	
DATE DISPLAY STYLE (For data disc only)	
Sorts the dates in order. (year.month.day / month.day.year / day.month.year)	
TIME DISPLAY CHOICE (For data disc only)	
For specifying the time display. (12h / 24h)	

* For resume function, the stop position will be reset if the burner is connected to an Everio or a PC via the USB cable, or when the burner is turned off and the disc is removed.

Screen Displays

You can display information during playback on the screen.

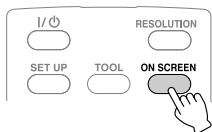

- Press each time to hide/show information.

■ During playback of AVCHD disc copied from a high definition Everio

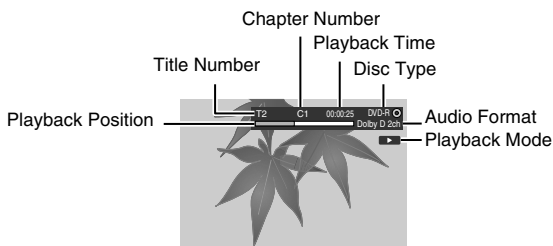

■ During playback of video data disc copied from a high definition Everio

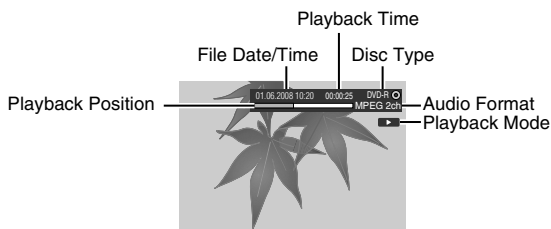

■ During playback of still image data disc copied from a high definition Everio

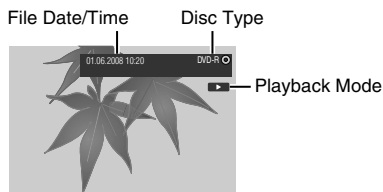

■ During playback of DVD disc copied from Everio

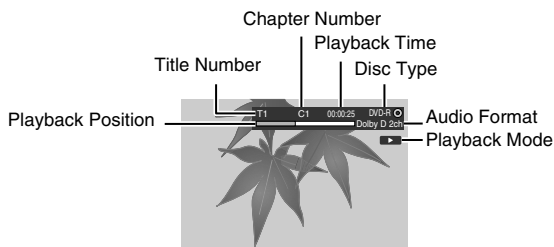

Troubleshooting

	Trouble	Action
General	Cannot turn the power on.	<ul style="list-style-type: none">● Make sure the AC adapter and power cord are properly connected. (P. 2)
	Cannot function properly.	<ul style="list-style-type: none">● Press the power button on this burner for more than 5 seconds to reset the burner. (The burner will turn off automatically.)
	The burner or AC adapter is hot.	<ul style="list-style-type: none">● The burner and AC adapter will become hot with prolonged use. This is not a malfunction.● If the burner is abnormally hot, remove the AC adapter and consult the dealer from which the burner is purchased.
	The power lamp blinks slowly in red while using the burner.	<ul style="list-style-type: none">● The burner cannot function properly due to a drop in its interior temperature. Wait until the power lamp stops blinking.● There is a rise in the burner's interior temperature. Turn off the burner, wait for a while then turn on again.
Copy	The burner is not recognised by the Everio camera.	<ul style="list-style-type: none">● Make sure the USB cable is connected properly. Insert the connector with the protrusion to the burner, and the other end to the Everio camera. (P. 14)
	The burner is not recognised by the PC.	<ul style="list-style-type: none">● Make sure the USB cable provided with the Everio camera is connected properly. (P. 16)
	Writing fails.	<ul style="list-style-type: none">● Use discs recommended for the burner. (P. 48)● Insert the disc with the label facing up.● Wipe off any dirt that is found on the tray.● Use discs for which the writing surface is not damaged.● Do not use deformed discs.
	Cannot open the disc tray.	<ul style="list-style-type: none">● If disc writing is currently in progress, the disc tray cannot be opened. Wait till the writing process ends.● If the disc cannot be properly ejected after the burner is dropped or due to other malfunctions, insert a thin rod into the force eject hole to eject the disc. (P. 44)
	Unable to write/read data at the maximum speed (when connected to a PC)	<ul style="list-style-type: none">● Use the recommended discs. (P. 48)

Trouble	Action
The remote control is not working.	<ul style="list-style-type: none"> ● The remote control is not operable when the disc tray is opened. Close the disc tray.
Unable to operate.	<ul style="list-style-type: none"> ● If the burner does not work at all, remove the power plug and insert again. (It may not function properly due to lightning strike or static electricity.)
No images on the TV.	<ul style="list-style-type: none"> ● Connect this burner to a TV. (P. 12, 13) ● Switch to the external output that connects the burner to the TV with a video/audio input connectors. ● After pressing the power button, it will take about 25 seconds to display the intermediate screen. (P. 34) ● If there are too many recorded files or when a disc that is not recommended is used, it will take several minutes to display the playback navigator. ● Check the resolution setting again. (P. 33)
Images are distorted during fast-forward/fast-reverse playback.	<ul style="list-style-type: none"> ● Images may be distorted for sections where the playback speed changes. This is not a malfunction.
The images cannot be displayed in the normal aspect ratio.	<ul style="list-style-type: none"> ● When both the HDMI terminal and Audio/Video output connectors are connected, set "HDMI VIDEO MODE" in the settings menu to "OFF" to output the images with priority given to the Audio/Video output connectors. (P. 36)
Reading fails.	<ul style="list-style-type: none"> ● Insert the disc with the label facing up. ● Wipe off any dirt that is found on the tray. ● Make sure that the writing surface of the disc is not damaged. ● Do not use deformed discs.
Playback cannot function properly.	<ul style="list-style-type: none"> ● Playback of commercial DVD-Video is not guaranteed.
Digest Playback starts when the PREVIOUS / NEXT button is pressed repeatedly.	<ul style="list-style-type: none"> ● AVCHD disc created on a high definition Everio is equipped with the Digest Playback function. If the PREVIOUS / NEXT button is pressed repeatedly during playback, Digest Playback will start when the normal playback ends. (P. 24)

Trouble	Action
Unable to read the content of the AVCHD disc using the PC's explorer function.	<ul style="list-style-type: none"> ● The PC's operation system does not support the AVCHD disc. Install the Power2Go software provided.
Unable to play back images added by a PC.	<ul style="list-style-type: none"> ● When playing back a disc (multi-border disc) containing images added by a PC, the added images cannot be played back.
The TV switches input automatically when the burner is played.	
The TV turns off when this burner is turned off.	
This burner functions when the TV's remote control is being operated.	

Problems with seamless playback

During continuous playback of multiple files, the image will freeze for a few seconds while switching the files in the following cases.

- When the recording dates are different:
The image will freeze for a few seconds when switching between files with different recording dates.
For files with the same date, playback is seamless.
- When files are deleted:
If files are deleted and added after deleting during continuous recording, the image will freeze for a few seconds at the part where deleting is done.
When no files are deleted, playback is seamless.
- When the picture quality (XP/SP/EP) is changed during recording:
The image will freeze for a few seconds when switching between files with different picture quality.
For files recorded in the same picture quality, playback is seamless.
- When the recorded file is less than 3 seconds:
The image will freeze for a few seconds at the end of a file that is less than 3 seconds.
- When more than 99 files with the same date are recorded:
The image will freeze for a few seconds when switching between files at every 99 file recordings.
For continuous 99 files, playback is seamless.

Disc cannot be ejected

When a disc cannot be ejected with the eject button, use the following procedure to eject by force.

- ① Turn off this burner.
- ② Insert a thin rod into the force eject hole located next to the eject button and the tray will be ejected.
- ③ Pull out the tray manually and remove the disc.

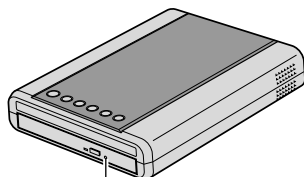

Force eject hole

Error Messages

Trouble	Action
Unplayable disc	<ul style="list-style-type: none">● The disc may be dirty. Clean the disc and try again.● The disc or data format is not supported. Check the disc or data format (extension). (P. 49)
Incompatible disc	<ul style="list-style-type: none">● Insert a disc that can be played on this burner. (P. 49)● The “Close disc” check box in Power2Go might have been unchecked to allow further recording. Under the “Burner” tab in the Power2Go “Configuration/Information” menu, check the box to close the disc. (P. 16)
Unfinalized disc Use finalized disc	<ul style="list-style-type: none">● Disc is not finalised when it is copied from the high definition Everio. Make sure to finalise the disc after copying. (For details, refer to the instruction manual of the Everio camera.)
Disc error	<ul style="list-style-type: none">● The disc may be dirty. Clean the disc and try again.
Region code error	<ul style="list-style-type: none">● Discs with a region code that differs from the region code set for this burner cannot be played back. Insert a disc with a region code that matches the region code of this burner. (P. 46)
Cannot execute the operation	<ul style="list-style-type: none">● Operate after stopping playback.
Cannot play back	<ul style="list-style-type: none">● File data may be missing.● The disc or data format is not supported. Check the disc or data format (extension). (P. 49)
No video files stored	<ul style="list-style-type: none">● You have selected a folder that does not contain any videos. Select a folder with video files. (P. 25)
No image files stored	<ul style="list-style-type: none">● You have selected a folder that does not contain any still images. Select a folder with still image files. (P. 25)

Other Information

Cleaning Procedure

IMPORTANT:

- Be sure to unplug the burner before beginning cleaning.
- Do not use liquid or aerosol cleaners.
- Ensure that no moisture or liquid comes into contact with the drive during cleaning.

Exterior of the Burner:

Wipe dirt off with a dry cloth.

Disc Tray:

Wipe off dirt with a soft dry cloth.

Do not touch the lens. To clean the lens, use commercially available lens cleaning blower for cameras. Using a lens cleaning disc will cause malfunction.



Disc:

Use a commercially available cleaning cloth to gently wipe from the inner edge to the outer edge.

Do not paste any stickers on the label side of the disc. This will cause the center of rotation to deviate and increase the vibration of the rotating disc thereby affecting proper playback.

Storage:

Make sure that discs are kept in their cases. If discs are piled on top of one another without their protective cases, they can be damaged. Do not put discs in a location where they may be exposed to direct sunlight, or in a place where the humidity or temperature is high. Avoid leaving discs in your car!

Region Codes

Region codes are numbers for restricting DVD video playback. The world is separated into six regions and each region is identified by a number. If the number for a disc does not match the number for the player, the disc cannot be played on the player.

Disclaimer

JVC accepts no liability whatsoever for loss of data resulting from inappropriate connections or handling.

Copyrights

Duplicating copyright protected material, for other than personal use, without the permission of the copyright holder is prohibited by copyright law.

Registered Trademarks and Trademarks

- Microsoft, Windows, and Windows Vista are either registered trademarks or trademarks of Microsoft Corporation in the United States and/or other countries.
- Macintosh and Mac OS are trademarks of Apple, Inc., registered in the United States and other countries.
- Pentium is a registered trademark of Intel Corporation in the United States.
- Manufactured under licence from Dolby Laboratories. “Dolby” and the double-D symbol are trademarks of Dolby Laboratories.
- HDMI, the HDMI logo and high definition multimedia interface are trademarks or registered trademarks of HDMI Licensing LCC.
- The x.v.Color and x.v.Color logos are trademarks.
- The AVCHD and AVCHD logos are trademarks of Matsushita Electric Industrial Co., Ltd. and Sony Corporation.
- Other company and product names mentioned herein are registered trademarks and/or trademarks of their respective holders.

Specifications

General

Rated current	2.3 A
Dimensions	152 x 42 x 195 mm (W x H x D)
Mass	Approx. 920 g (excluding AC adapter and connection cables)
Operating environment	Operating temperature: 0 °C to 35 °C Storage temperature: -20 °C to 60 °C
Laser power (wavelength, output)	For DVD: 656 to 663 nm, 1.04 mW For CD: 777 to 788 nm, 1.33 mW

AC adapter (AP-V50U)

Power supply	AC110 V to 240 V, 50 Hz/60 Hz
Input capacity	0.6 A
Output	DC 5.3 V, 3.5 A
Operating temperature	0 °C to 40 °C
Dimensions	52 x 31 x 120 mm (W x H x D, excluding power cord)
Mass	Approx. 136 g

Remote control (RM-V55U)

Type	DC 3 V (CR2025 button battery)
Battery life	Approx. 1 year (depending on the frequency of use)
Operating distance	Approx. 5 m (face up)
Operating temperature	0 °C to 40 °C
Dimensions	42 x 12 x 100 mm (W x H x D)
Mass	Approx. 32 g (including lithium battery)

Recommended discs

DVD-R	JVC, TDK, Verbatim, SONY
DVD-R DL *1	JVC *2, Verbatim
DVD-RW	JVC

- Use of this burner may not be possible or optimal performance may not be achieved depending on the disc used. We suggest using the recommended discs.
- Use DVDs for videos.
- This burner supports only 12 cm discs.
- The appearance and specifications of this product may be modified without prior notice.

*1 DVD-R DL discs can be used when the burner is connected to a high definition Everio and PC.

*2 For DVD-R DL manufactured by JVC, use of discs with the "Also recommended for high definition Everio" message stated is recommended.

Playback feature

Discs supported	DVD-R, DVD-R DL, DVD-RW
Data format (extension)	<ul style="list-style-type: none"> ● AVCHD or DVD data disc created by connecting to a high definition Everio ● DVD video disc created by connecting to Everio ● DVD data disc for which data is recorded using the high definition Everio, processed using an editing software of Everio, and written to a specific folder on this burner <ul style="list-style-type: none"> • Select the file format for GZ-HD series as the output format in the PowerDirector output menu. • Set the file system under the data tab in the Power2Go 5.5 Lite configuration menu to “UDF 1.5”. • If images created by selecting “SVRT” in the PowerDirector output menu cannot be played back correctly, deselect “SVRT” and execute again. ● Extensions recognised by this burner are as follows. (Extensions that have been changed cannot be played back properly.) <ul style="list-style-type: none"> • Data recorded on Everio (via PC): MTS, TOD, MOD, JPG • Data edited on PC: JTS, TPD, JPG • When playing back a file created on a PC, pressing the PLAY button after searching may cause the playback position to deviate.
Video output	1.0 V 75 Ω (Pin jack)
Audio output	2.0 Vrms (Pin jack)
Component video output	Y p-p: 1.0 V 75 Ω (Pin jack) Cb/Cr, Pb/Pr p-p: 0.7 V 75 Ω (Pin jack)
HDMI output terminal	19-pin HDCP, x.v.Color, Deep Color compliant Video: 1080p / 1080i / 720p / 576p* / 576i* (We do not provide guarantee for compatibility with DVI-D.) Audio: 2CH PCM/bit stream

* For NTSC system, the video output format is 480p or 480i.

Caution

- Discs other than those above cannot be played back properly.

When connected to an Everio camera

Interface	USB 2.0	
Interface cable	USB cable (Mini A type - Mini B type)	
Compatible discs for writing (8 cm discs cannot be used)	Everio	DVD-R, DVD-RW
	High definition Everio	DVD-R, DVD-R DL, DVD-RW
Recording format	Everio	DVD-Video (video only)
	High definition Everio	AVCHD disc (video) Data disc (video, still image)
Recording time	Everio	Approx. 30 minutes (including time for finalisation) When recording videos for about 90 minutes in the Fine mode to a 4.7 GB disc. (This may vary according to conditions such as the number of titles.)
	High definition Everio	AVCHD disc: Approx. 60 minutes (including time for finalisation) <ul style="list-style-type: none"> • When recording videos for about 60 minutes in the XP mode to a 8.5 GB DVD-R DL disc. (This may vary according to conditions such as the number of files.) Data disc: Approx. 45 minutes (including time for finalisation) <ul style="list-style-type: none"> • When recording videos for about 40 minutes in the FHD mode to a 8.5 GB DVD-R DL disc. (This may vary according to conditions such as the number of files.)

- GZ-MC100, GZ-MC200, GZ-MC500, GZ-MG20, GZ-MG40, GZ-MG50, and GZ-MG70 cannot be used.

When connected to a PC

Interface	USB 2.0, USB 1.1 *1	
Interface cable	USB cable (USB cable provided with Everio can also be used)	
Supported operating system	Windows® XP Home Edition, Windows® XP Professional Windows Vista™ Home Basic, Windows Vista™ Home Premium (Macintosh is not supported.)	
Data buffer capacity	2 MB	
Data transfer rate (for USB 2.0)	Writing	DVD-R: Maximum 8x DVD-RW: Maximum 6x DVD-R DL: Maximum 6x
	Reading	DVD-R: Maximum 8x DVD-RW: Maximum 8x DVD-R DL: Maximum 8x CD-R: Maximum 24x *2 CD-RW: Maximum 24x *2 CD-ROM: Maximum 24x
Compatible discs (8 cm discs cannot be used)	Writing	DVD-R, DVD-RW, DVD-R DL
	Reading	DVD-R, DVD-RW, DVD-R DL, CD-ROM, CD-R, CD-RW
Supported software	PowerProducer 4 NE (provided with Everio) CyberLink Power2Go 5.5 Lite (provided with CU-VD50)	

*1 If you are using a USB 1.1 cable, it will take approximately 3 hours to write one DVD.

*2 Any CD recorded using the packet-write method is not supported.

JVC